

**RoHS**  
Compatible

R&D發行  
2018.11.28  
達立

△				
△				
△				
△				
ZONE	REV	DESCRIPTION	DATE	APPD.

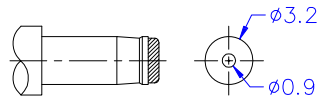

DC Mate plug

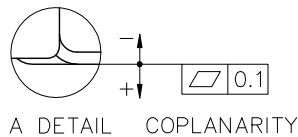
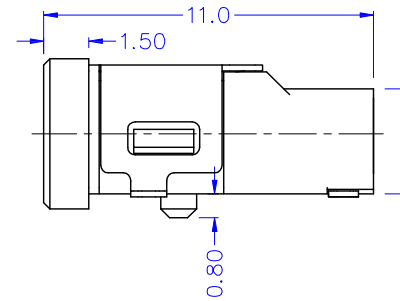
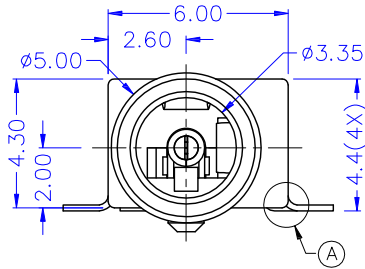
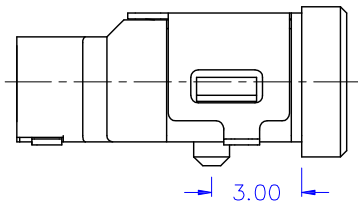
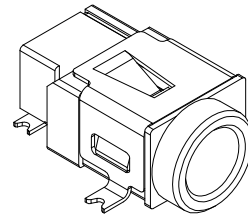

SCHEMATIC		1
		2
		3
CENTER PIN		∅0.8mm

Material :  
Terminal 1 : Brass, Ag Plated  
Terminal 2 : Copper alloy, Ag Plated  
Terminal 3 : Copper alloy, Ag Plated  
Housing : PA10T

RECOMMEN P.C.B MOUNTING  
PATTERN DIMENSION

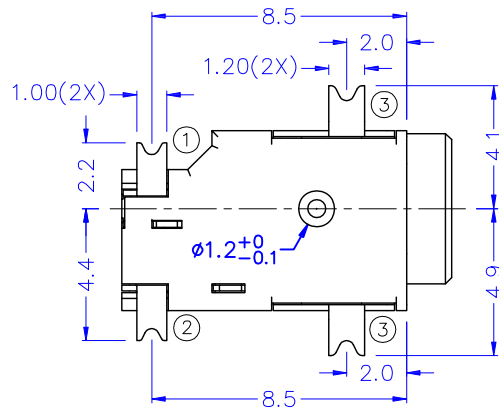
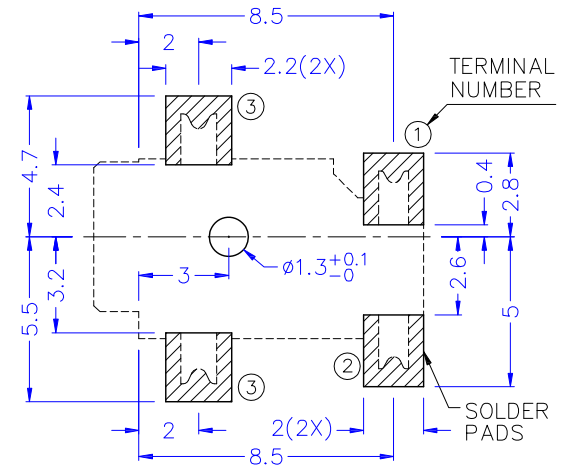

達立科技股份有限公司

Dawning Precision Co., Ltd.  
TEL: 886-2-82271388 FAX: 886-2-82272198

DESIGN	Jeff	SCALE			TOLERANCE UNLESS OTHERWISE STATED(mm) 0 _____ ±0.30 0.0 _____ ±0.20 0.00 _____ ±0.10 ANGLE _____ ±2°
DRAWING	Jeff	UNIT	mm		
CHECK	Jeff	SIZE	A4: 210*297		
APPROVAL	Honda	VERSION	01		

PART NAME	DC POWER SOCKET
PART NO	DC-042D-S011
DRAWING NO	
DATE	2018/11/28

www.dawning2.com.tw