

RoHS
Compatible

RD&發行
2023.09.05
達立

△				
△				
△				
△				
ZONE	REV	DESCRIPTION	DATE	APPD.

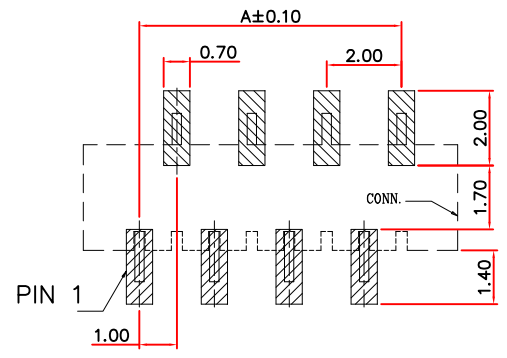
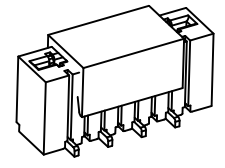

RECOMMENED P.C.B MOUNTING
(PCB TOLERANCE ±0.05)

PIN NO.	Dimensions		
	A	B	C
4	3.00	5.05	6.00
5	4.00	6.05	7.00
6	5.00	7.05	8.00
7	6.00	8.05	9.00
8	7.00	9.05	10.00
9	8.00	10.05	11.00
10	9.00	11.05	12.00
11	10.00	12.05	13.00
12	11.00	13.05	14.00
13	12.00	14.05	15.00
14	13.00	15.05	16.00
15	14.00	16.05	17.00
16	15.00	17.05	18.00

PIN NO.	Dimensions		
	A	B	C
17	16.00	18.05	19.00
18	17.00	19.05	20.00
19	18.00	20.05	21.00
20	19.00	21.05	22.00
21	20.00	22.05	23.00
22	21.00	23.05	24.00
23	22.00	24.05	25.00
24	23.00	25.05	26.00
25	24.00	26.05	27.00
26	25.00	27.05	28.00
27	26.00	28.05	29.00
28	27.00	29.05	30.00
29	28.00	30.05	31.00
30	29.00	31.05	32.00

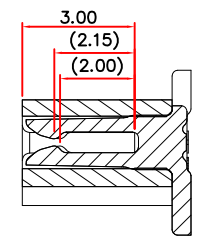
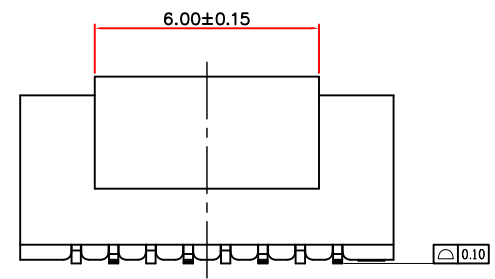
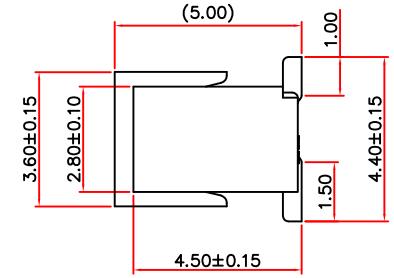
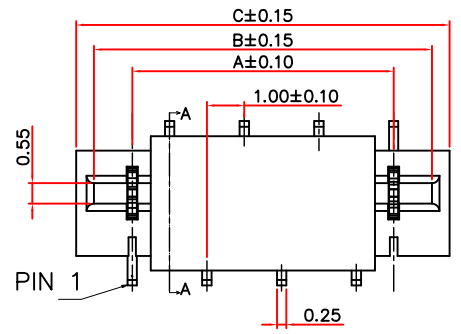

SECTION A-A

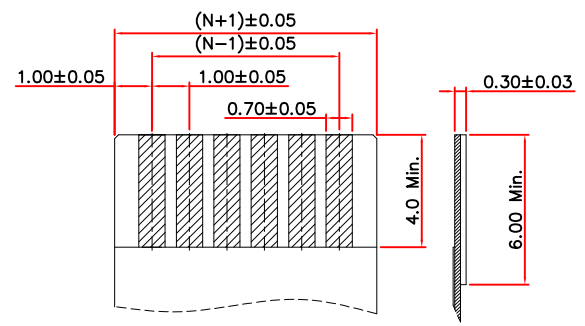

(Applicable Flat Cable)

Order information :
FP104501-XX X XX B-S209
 1 2 3 4

- Pin No. 04~30
- Packing :
0 = Tape & Reel
1 = Tube
- Plating spec :
TO = Bright Tin
TM = Matte Tin
- Color :
B = Black

Specifications

- Rating : 0.5A, 50V AC,DC
- Contact resistance : 30mΩ Max.
- Insulation resistance : 500MΩ Min.
- Withstand voltage : 500V AC
- Temperature Range : -25°C ~ +85°C

No.	Part Name	Material	Qty	Finishing
3	Cap	LCP ,UL94 V-0	1	Black
2	Contact	Copper alloy	1	Sn Plated
1	Housing	LCP ,UL94 V-0	1	Black

達立科技股份有限公司
Dawning Precision Co., Ltd.
TEL: 886-2-82271388 FAX: 886-2-82272198

DESIGN	Jeff	SCALE		
DRAWING	Jeff	UNIT	mm	
CHECK	Jeff	SIZE	A4: 210*297	
APPROVAL	Baker	VERSION	03	

TOLERANCE UNLESS OTHERWISE STATED(mm)	PART NAME	FPC 1.0mm PITCH H=4.5mm
0 _____ ±0.50	PART NO	FP104501-XXXXXB-S209
0.0 _____ ±0.25	DRAWING NO	
0.00 _____ ±0.15	DATE	2023.09.25
ANGLE _____ ±2°		