

△				
△				
△				
△	02	Update drawing	122513	Frank
ZONE	REV	DESCRIPTION	DATE	APPD.

Order Information:
TSS10-NT2-160-T30

carrier tape quantity
force
model type
tact switch model

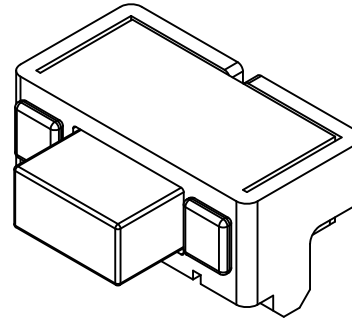

發行
2013.12.25
達立

RoHS
Compatible

P.C.B MOUNTING
PATTERN DIMENSION

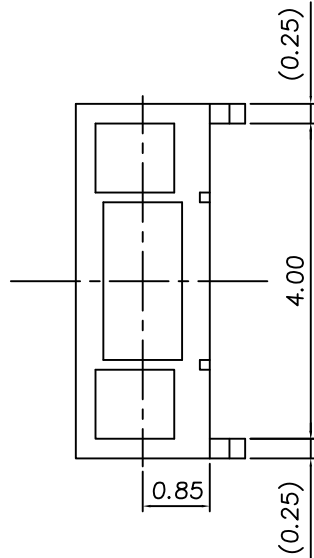
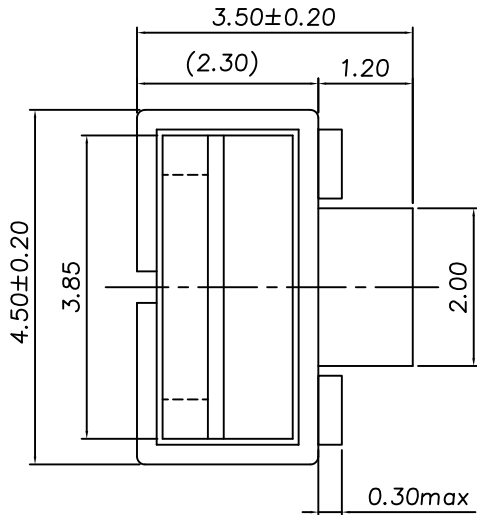

CIRCUIT DIAGRAM

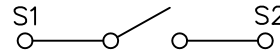

SPECIFICATIONS

1. Rating : DC12V , 20mA max.
2. Circuit : 1C-1P
3. Travel : 0.2±0.1mm
4. Contact resistance : 100mΩ Max.
5. Operating force : 160±50gf
6. Operating life : 100,000 cycles Min.

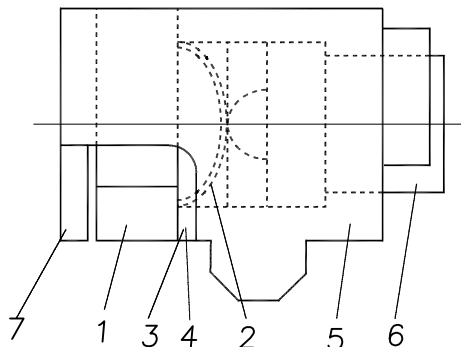
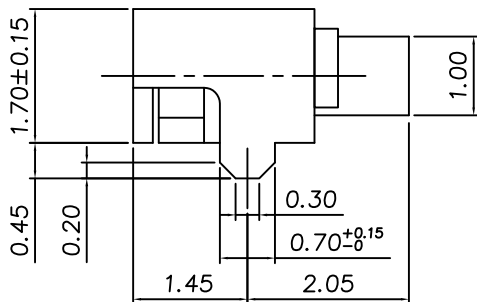
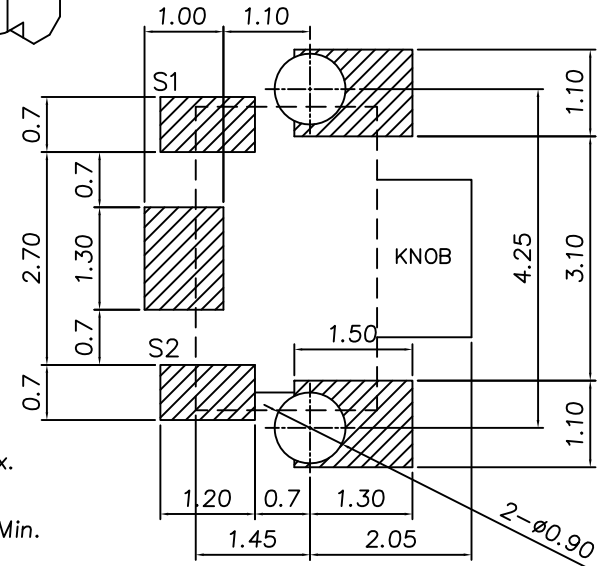

7	Cover	SPTe	1	Sn 2.5um Plated Min.
6	Knob	PPA 30%GF	1	94HB
5	Case	PPA 30%GF	1	94HB
4	Waterproof Sheet	PI Film	1	94V-0
3	Ashesive Sheet	PI Film	1	94V-0
2	Contact	Stainless Steel	1	Ag 0.1um Plated Min.
1	Circuit Board	PCB 30%GF	1	94V-0
NO	Part Name	Material	Q"ty	Finishing

達立科技股份有限公司



Dawning Precision Co., Ltd.

TEL: 886-2-82271388 FAX: 886-2-82272198

DESIGN	Frank	SCALE	
DRAWING	Frank	UNIT	mm
CHECK	Frank	SIZE	A4: 210*297
APPROVAL	Eric	VERSION	02



TOLERANCE UNLESS
OTHERWISE STATED(mm)
less than 10 — ±0.2
10~30 — ±0.3
30~100 — ±0.5
ANGIE — ±2'

PART NAME	TACT SWITCH
PART NO	TSS10-NT2-160-T30
DRAWING NO	
DATE	2013/12/25