

RoHS
Compatible

△				
△				
△				
△				
ZONE	REV	DESCRIPTION	DATE	APPD.

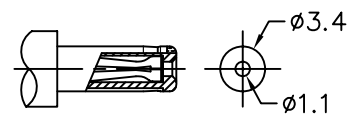

DC MATE PLUG

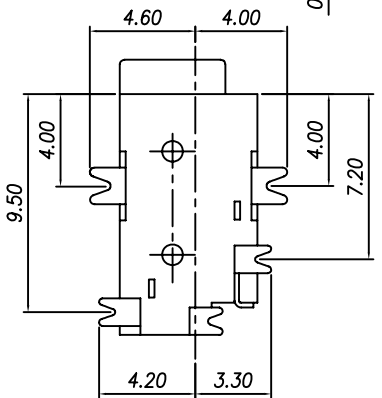
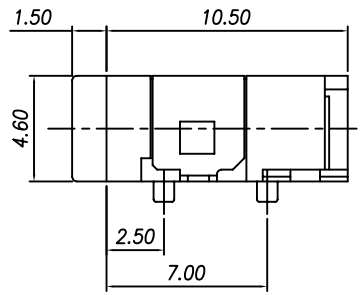
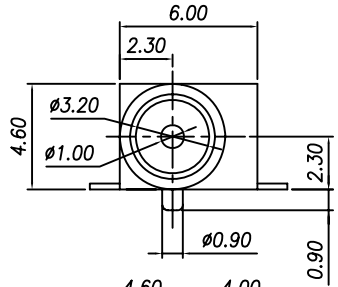
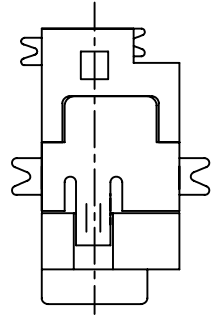
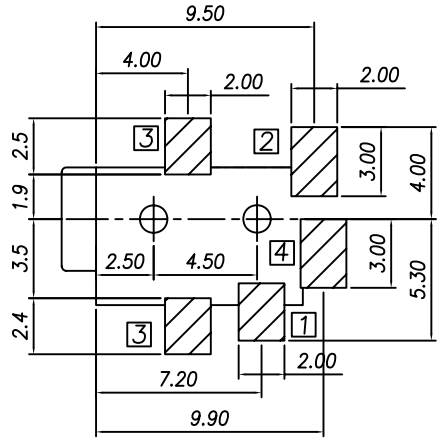

RECOMMENDED P.C.B. LAYOUT
UNSPECIFIED TOLERANCE: ±0.1
(Top View)

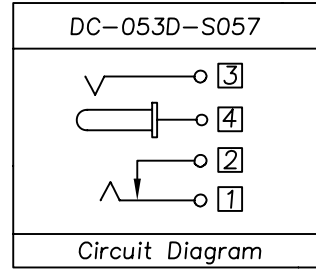

□ : Terminal No.

- Specification:
- 1.Rating : DC 30V 0.5A;
 - 2.Contact resistance: ≤30mΩ;
 - 3.Insulation resistance: ≥100MΩ(250VDC);
 - 4.Withstand voltage: 500VAC ;
 - 5.Insertion and extraction force: 3N~30N;
 - 6.life test: 5,000cycles Cycles.

發行
2011.03.25
達立

⑤	Housing	1	PA9T	
④	Pin	1	Phosphor Bronze	Ag/Au-Plated
③	Contact Foot	1	Phosphor Bronze	Ag/Au-Plated
②	Curve Piece	1	Brass	Ag/Au-Plated
①	Spring	1	Phosphor Bronze	Ag/Au-Plated
NO.	Description	Qty	Material	Remark

達立科技股份有限公司
Dawning Precision Co.,Ltd.
TEL: 886-2-82271388 FAX: 886-2-82272198

DESIGN	Will	SCALE	
DRAWING	Will	UNIT	mm
CHECK	Will	SIZE	A4: 210*297
APPROVAL	Eric	VERSION	01

TOLERANCE UNLESS OTHERWISE STATED(mm)	PART NAME	DC POWER SOCKET
less than 10 — ±0.2	PART NO	DC-053D-S057 SERIES
10~30 — ±0.3	DRAWING NO	
30~100 — ±0.5	DATE	2011/03/25
ANGIE — ±2°		