

**RoHS**  
Compatible

RD&發行  
2023.05.23  
達立

Order information :  
18176-9K7A1-S186  
1 2 3 4 5

- Housing material  
9 = Thermoplastic
- Housing color  
K = Black
- Shell material & plating  
7=Stainless / Ni
- Contact plating  
A = Au Plated
- Packing  
1 = Tape & Reel

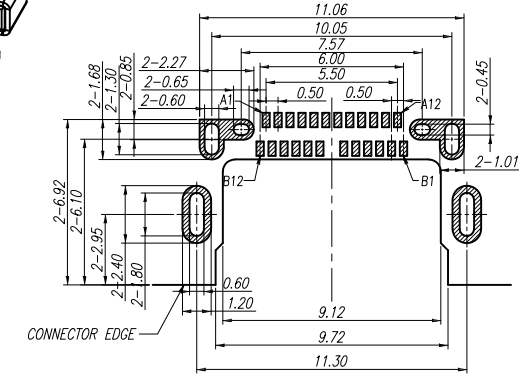
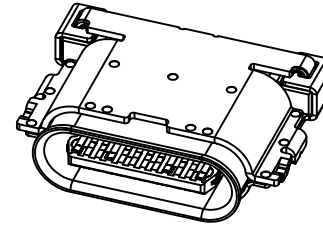

RECOMMEN P.C.B MOUNTING  
TOLERANCE: ±0.05

△				
△				
△				
△				
ZONE	REV	DESCRIPTION	DATE	APPD.

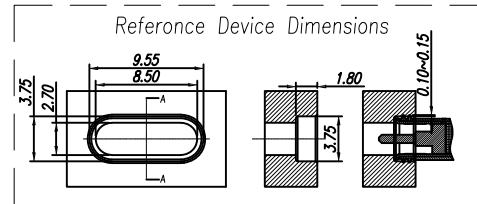
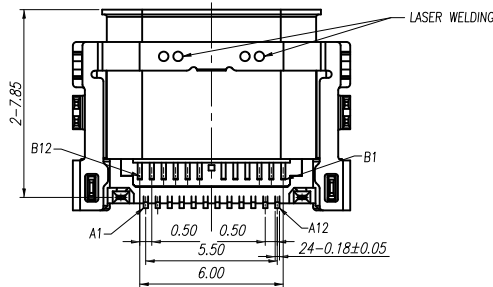
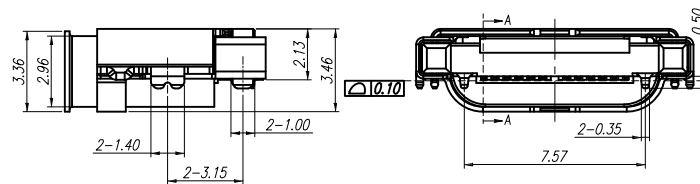
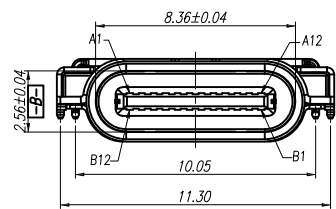
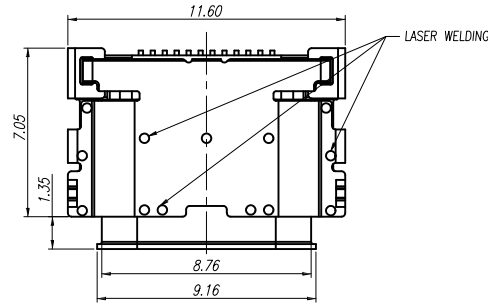

**Specifications**

- Current Rating: 5.0 A
- Contact resistance: 30mΩ Max.
- Insulation resistance: 100MΩ Min.
- Dielectric withstanding voltage: 100V AC/1 minute
- Insertion force: 5~20N
- Removal force: 8~20N
- Durability : 10,000 Cycles
- Operation Temperature : -40°C ~ +85°C

PIN ASSIGNMENT												BLADE	SHELL
A1	A2	A3	A4	A5	A6	A7	A8	A9	A10	A11	A12		
GND	TX1+	TX1-	VBUS	CC1	D+	D-	SBU1	VBUS	RX2-	RX2+	GND		
GND	RX1+	RX1-	VBUS	SBU2	D-	D+	CC2	VBUS	TX2-	TX2+	GND	GND	GND
B12	B11	B10	B9	B8	B7	B6	B5	B4	B3	B2	B1		

3	Contact	Copper Alloy	1	Au & Ni Plated
2	Housing	Plastic	1	Black
1	Shell	Stainless Steel	1	Ni Plated
No.	Part Name	Material	Q'ty	Finishing

達立科技股份有限公司



Dawning Precision Co., Ltd.

TEL: 886-2-82271388 FAX: 886-2-82272198

DESIGN	Jeff	SCALE		
DRAWING	Jeff	UNIT	mm	
CHECK	Jeff	SIZE	A4: 210*297	
APPROVAL	Baker	VERSION	01	

TOLERANCE UNLESS OTHERWISE STATED(mm)	PART NAME	USB C TYPE
0 _____ ±0.30	PART NO	18176-9K7A1-S186
0.0 _____ ±0.25	DRAWING NO	
0.00 _____ ±0.20	DATE	2023/05/23
ANGIE _____ ±5°		