

△				
△				
△				
△				
ZONE	REV	DESCRIPTION	DATE	APPD.

RoHS
Compatible

R&D發行
2022.10.14
達立

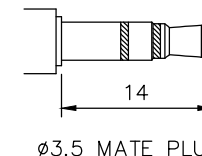
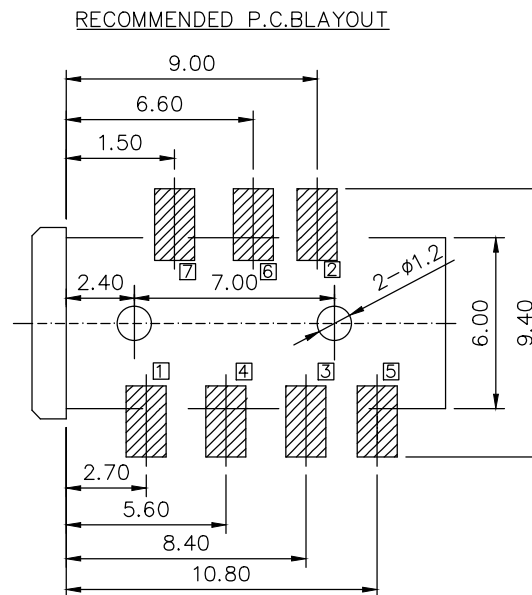
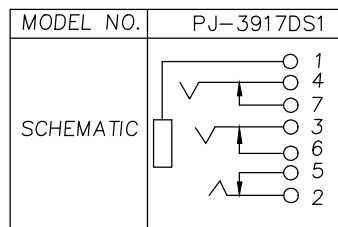
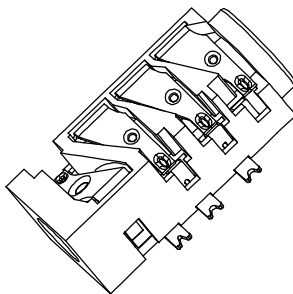
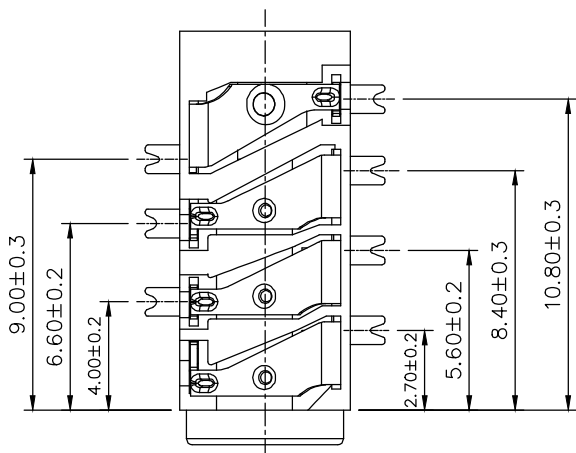

Specifications

- Rating : DC 12V, 1A.
- Contact resistance : 50mΩ Max.
- Insulation resistance : 100MΩ Min.
- Withstand voltage : 500VAC
- Insertion and extraction force : 3-30N
- Operating life : 5,000 cycles
- Operation temperature range : -20°C~85°C

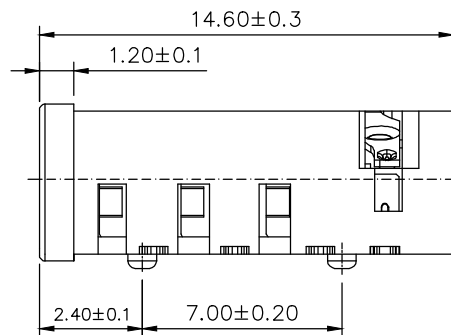
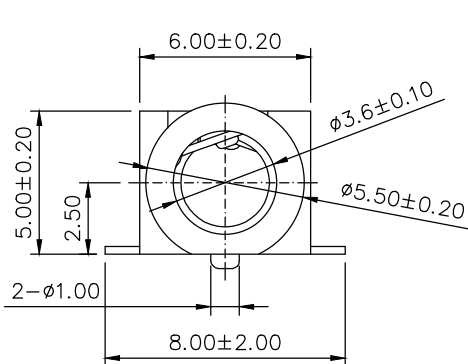

8	Housing	PPA	1	Black
7	Terminal 7	Brass t0.25	1	Ag Plated
6	Terminal 6	Brass t0.25	1	Ag Plated
5	Terminal 5	Brass t0.25	1	Ag Plated
4	Terminal 4	Phosphor Bronze t0.25	1	Ag Plated
3	Terminal 3	Phosphor Bronze t0.25	1	Ag Plated
2	Terminal 2	Phosphor Bronze t0.25	1	Ag Plated
1	Terminal 1	Phosphor Bronze t0.25	1	Ag Plated
No.	Part Name	Material	Q'ty	Finishing

達立科技股份有限公司
Dawning Precision Co., Ltd.
TEL: 886-2-82271388 FAX: 886-2-82272198

DESIGN	Charles	SCALE		
DRAWING	Charles	UNIT	mm	
CHECK	Charles	SIZE	A4: 210*297	
APPROVAL	Baker	VERSION	01	

TOLERANCE UNLESS OTHERWISE STATED(mm)	PART NAME	PHONE JACK
0 ——— ±0.30	PART NO	PJ-3917DS1-S243
0.0 ——— ±0.25	DRAWING NO	
0.00 ——— ±0.20	DATE	2022/10/14
ANGLE ——— ±2°		