

△				
△				
△				
△				
ZONE	REV	DESCRIPTION	DATE	APPD.

Order information :  
18148-9K7A1-x-S186  
1 2 3 4 5

- Housing material  
9 = Thermoplastic
- Housing color  
K = Black
- Shell material & plating  
7=Stainless / Ni
- Contact plating  
A = Au Plated
- Packing  
1 = Tape & Reel

Model No.	DIM.A	DIM.B
18148-9K7A1-A	6.80	6.75
18148-9K7A1-B	6.80	6.90
18148-9K7A1-C	6.50	6.45



RECOMMENDED P.C.B MOUNTING  
(TOP VIEW) TOLERANCE: ±0.05

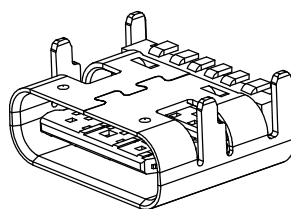
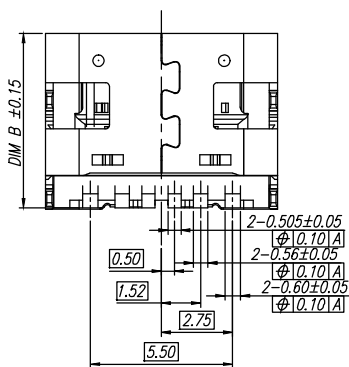
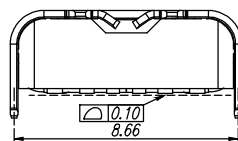
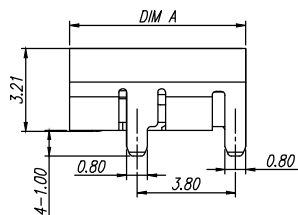
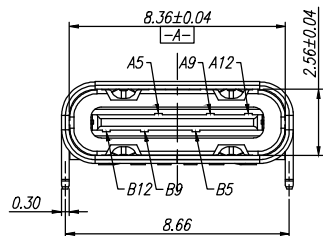
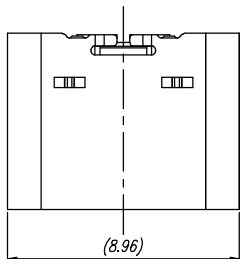
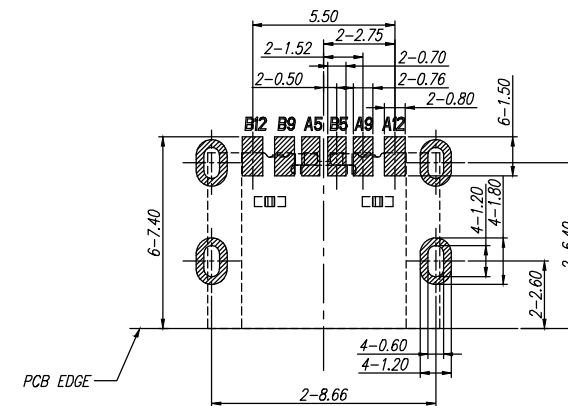

Specifications

- Current Rating: 3.0 A
- Contact resistance: 30mΩ Max.
- Insulation resistance: 100MΩ Min.
- Dielectric withstanding voltage: 100V AC/1 minute
- Insertion force: 5~20N
- Removal force: 8~20N
- Durability : 10,000 Cycles
- Operation Temperature : -40°C ~ +85°C

PIN ASSIGNMENT												BLADE	SHELL
A1	A2	A3	A4	A5	X6	X7	A8	A9	A10	A11	A12		
GND	TX1+	TX1-	VBUS	CC1	D+	D-	SBU1	VBUS	RX2+	RX2-	GND		
GND	RX1+	RX1-	VBUS	SBU2	D+	D-	CC2	VBUS	TX2+	TX2-	GND	GND	GND
B12	B11	B10	B9	B8	B7	B6	B5	B4	B3	B2	B1		

5	Out Shell	Stainless Steel	1	Ni Plated
4	Out Housing	Plastic	1	—
3	Contact	Copper Alloy	1	Au & Ni Plated
2	Molding Housing	Plastic	1	Black
1	Shell	Stainless Steel	1	Ni Plated
No.	Part Name	Material	Q'ty	Finishing

DESIGN	Charles	SCALE		
DRAWING	Charles	UNIT	mm	
CHECK	Charles	SIZE	A4: 210*297	
APPROVAL	Baker	VERSION	01	

TOLERANCE UNLESS OTHERWISE STATED(mm)		PART NAME	USB C TYPE
0	±0.30	PART NO	18148-9K7A1-x-S186
0.0	±0.25	DRAWING NO	
0.00	±0.20	DATE	2023/05/19
ANGIE	±5°		

達立科技股份有限公司

Dawning Precision Co., Ltd.  
TEL: 886-2-82271388 FAX: 886-2-82272198