

△				
△				
△				
△				
ZONE	REV	DESCRIPTION	DATE	APPD.

RD&發行
2023.05.22
達立

RoHS
Compatible

Order information :
18154-9K7A1-X-S186
1 2 3 4 5 6

- Housing material
9 = Thermoplastic
- Housing color
K = Black
- Shell material & plating
7=Stainless / Ni
- Contact plating
A = Au Plated
- Packing
1 = Tape & Reel
- Dim A
1 = 5.00mm
2 = 5.50mm
3 = 6.00mm
4 = 6.50mm
5 = 6.80mm

TABLE 1

P/N	DIM A	DIM B
18154-9K7A1-1-S186	5.00	6.25
18154-9K7A1-2-S186	5.50	6.50
18154-9K7A1-3-S186	6.00	7.00
18154-9K7A1-4-S186	6.50	7.50
18154-9K7A1-5-S186	6.80	7.80

Specifications

- Current Rating: 3.0 A
- Contact resistance: 30mΩ Max.
- Insulation resistance: 100MΩ Min.
- Dielectric withstanding voltage: 100V AC/1 minute
- Insertion force: 5~20N
- Removal force: 8~20N
- Durability : 10,000 Cycles
- Operation Temperature : -40°C ~ +85°C

1

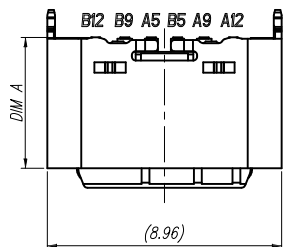

2

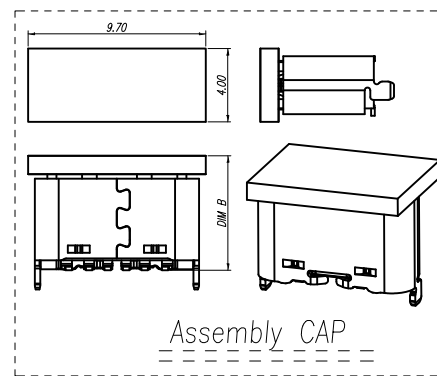
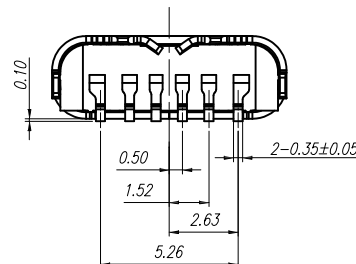
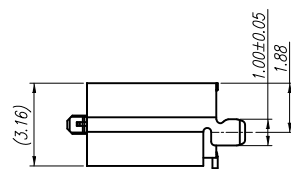
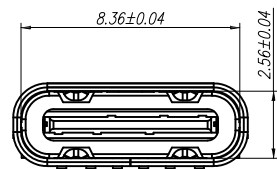

3

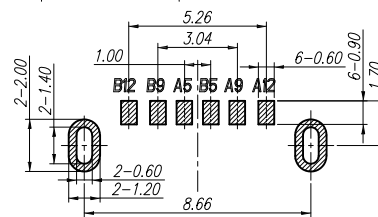
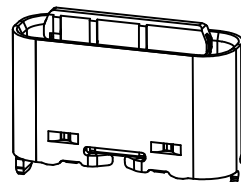
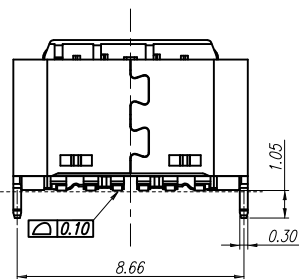

RECOMMENDED P.C.B MOUNTING
TOLERANCE: ±0.05

4

PIN ASSIGNMENT												BLADE	SHELL
A1	A2	A3	A4	A5	A6	A7	A8	A9	A10	A11	A12		
GND	TX1+	TX1-	VBUS	CC1	D+	D-	SBU4	VBUS	RX2+	RX2-	GND		
GND	RX1+	RX1-	VBUS	SBU2	D-	D+	CC2	VBUS	TX2-	TX2+	GND	GND	GND
B12	B11	B10	B9	B8	B7	B6	B5	B4	B3	B2	B1		

No.	Part Name	Material	Q'ty	Finishing
3	Contact	Copper Alloy	1	Au & Sn Plated
2	Housing	Plastic	1	Black
1	Shell	Stainless Steel	1	Ni Plated

達立科技股份有限公司

Dawning Precision Co.,Ltd.

TEL: 886-2-82271388 FAX: 886-2-82272198

DESIGN	Jeff	SCALE	
DRAWING	Jeff	UNIT	mm
CHECK	Jeff	SIZE	A4: 210*297
APPROVAL	Baker	VERSION	01

TOLERANCE UNLESS OTHERWISE STATED(mm)	PART NAME	USB C TYPE
0 — ±0.30	PART NO	18154-9K7A1-X-S186
0.0 — ±0.25	DRAWING NO	
0.00 — ±0.20	DATE	2023/05/22
ANGIE — ±5°		

www.dawning2.com.tw