

▲				
▲				
▲				
▲				
ZONE	REV	DESCRIPTION	DATE	APPD.

發行
2013.05.03
達立

RoHS
Compatible

Order Information:
TS-A52B-2-S017
Force

P.C.B MOUNTING
PATTERN DIMENSION

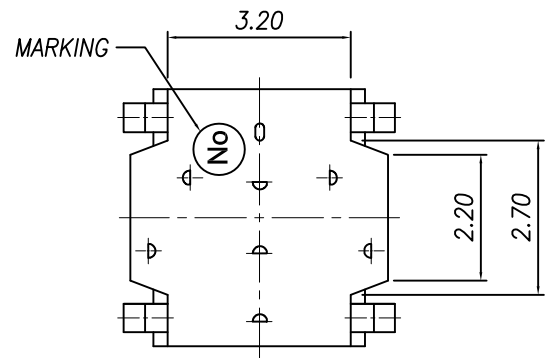
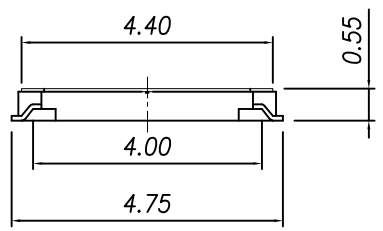
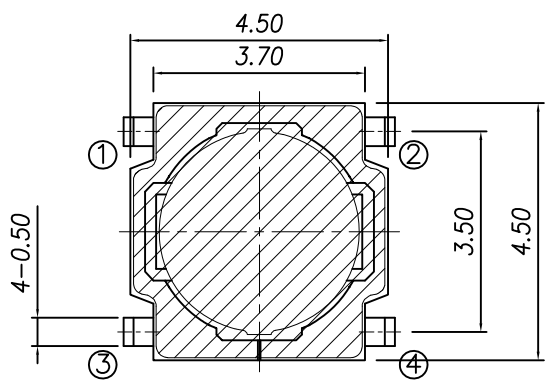

CIRCUIT DIAGRAM

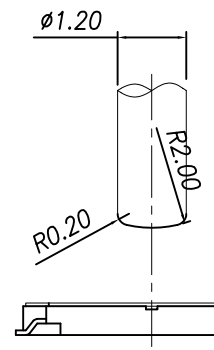
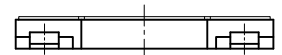
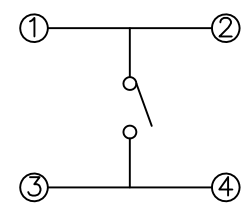

SET MARKER KNOB SIZE

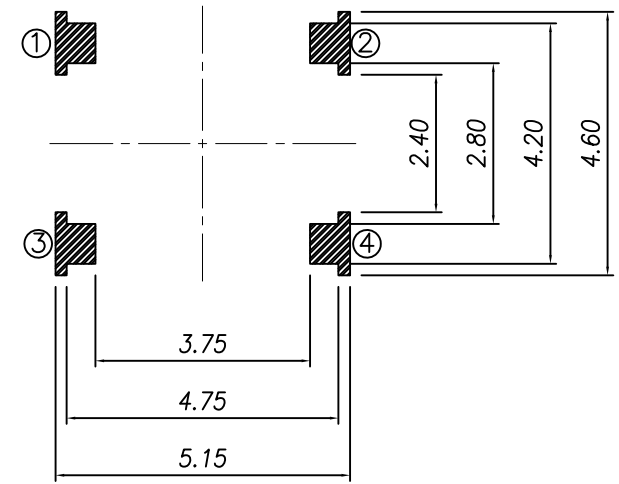

SPECIFICATIONS

1. Rating : 20mA 15V DC
2. Contact resistance : 100mΩ Max.
3. Insulation resistance : 100MΩ Min, 100V DC
4. Withstanding voltage : 250V AC for 1 minute
6. Travel : 0.2±0.1mm
7. Operating temperature range -20 to 70°

Model	Operating Force	Operating Life
TS-A52B-2	160±50gf	500,000 cycles

NO	Part Name	Material	Q"ty	Finishing
4	Contact	Stainless	1	Ag Clad
3	Masking Tpaе	PI Film	1	Yellow
2	Terminal	Phosphor Bronze	1	Plated : Ni 0.2um Min. , Ag 0.3um Min.
1	Case	Nylon46	1	Black

達立科技股份有限公司

Dawning Precision Co.,Ltd.

TEL: 886-2-82271388 FAX: 886-2-82272198

DESIGN	Frank	SCALE		
DRAWING	Frank	UNIT	mm	
CHECK	Frank	SIZE	A4: 210*297	
APPROVAL	Eric	VERSION	01	

TOLERANCE UNLESS OTHERWISE STATED(mm)	PART NAME	TACT SWITCH
less than 10 — ±0.2	PART NO	TS-A52B-2-S017
10~30 — ±0.3	DRAWING NO	
30~100 — ±0.5	DATE	2013/05/03
ANGIE — ±2°		